



WALLS | PAVERS | OUTDOOR LIVING KITS



**2019**  
**Collection**

Great Hardscapes Start Here®



INSPIRED OUTDOOR LIVING

## Building Values

For almost 40 years, Basalite® has worked on growing our business by building relationships. We have created strong bonds with our dealers, masons, architects, engineers and licensed contractors. From working together with the common purpose of installing the finest hardscape products available, we have seen our products placed in settings that range from practical to magical. At Basalite®, we are committed to being the best in the industry. Our focus now, just as it was when we opened our doors all those years ago, is on service, quality and innovation. Those are the values that have made us the industry leader we are today and the same principles that will guide us far into the future.



7



11



6



13



4



8

# Contents

## RETAINING & LANDSCAPE WALLS

Garden Stack	3
GeoWall® Pro	4
Valley Stone Half	5
Valley Stone	6

## PAVERS

Artisan Slate Premier	7
Mission Paving Stones	8

## DESIGN CONSIDERATIONS

Curves	9
Corners	10
Stairs	11
Terraces	12

## OUTDOOR LIVING KITS

Necessaries Kits	13
------------------	----

## SPECIFICATIONS

## INSTALLATION INSTRUCTIONS

## ESTIMATING CHARTS

## HARDSCAPES

## CIVIL SITE SOLUTIONS



# Garden Stack

LANDSCAPE & FREESTANDING WALL

Outdoor areas of any size or shape can be transformed with the Basalite Garden Stack freestanding wall. Textured on both sides the Garden Stack wall is attractive from all angles and is perfect for those small landscaping projects that require straight or curved walls.

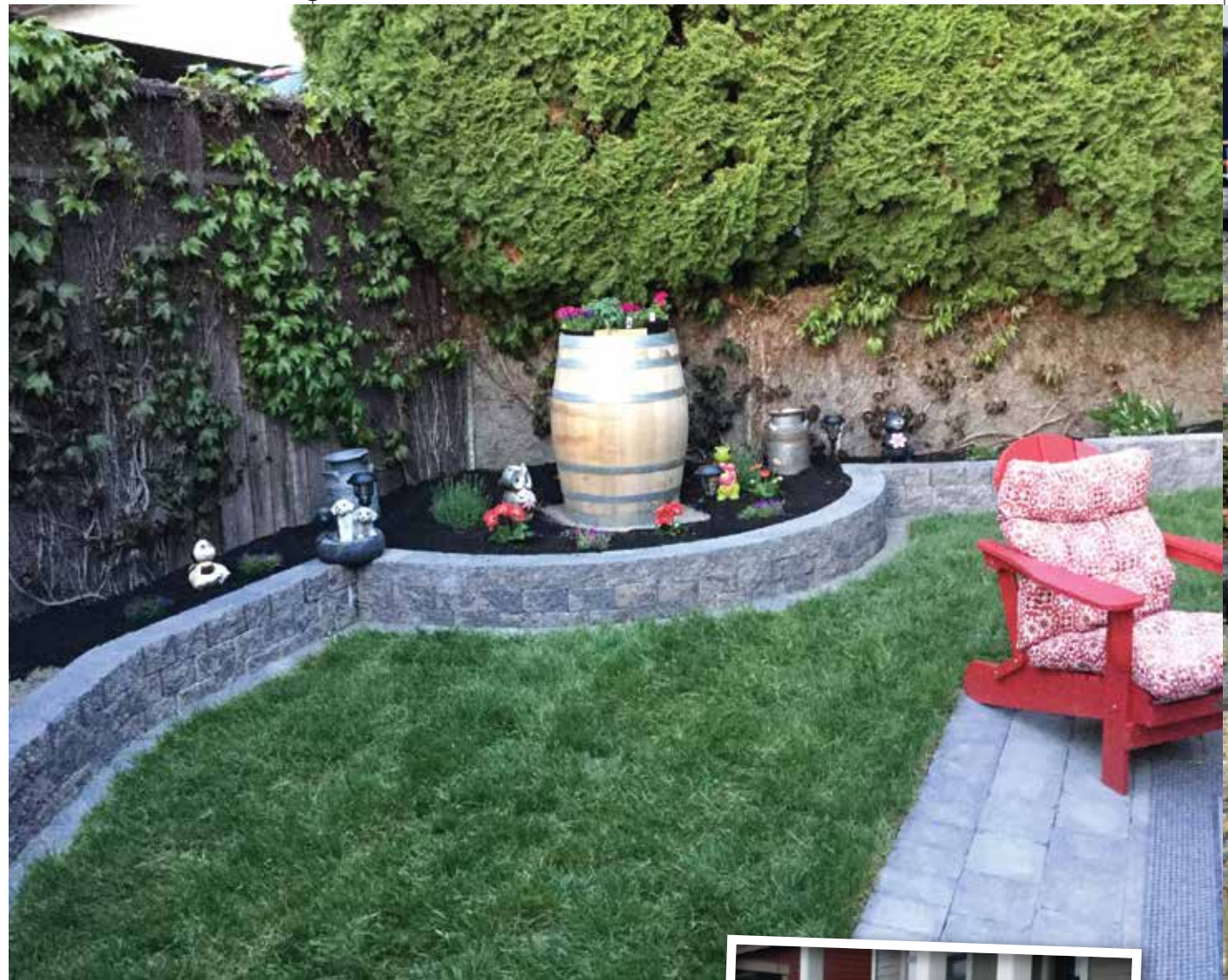

Above, right and below: Garden Stack in Tuscany colour.

## COLOURS



Roman



Tuscany

*Incorporate planters throughout your design to add colour and texture with flowers and shrubs.*



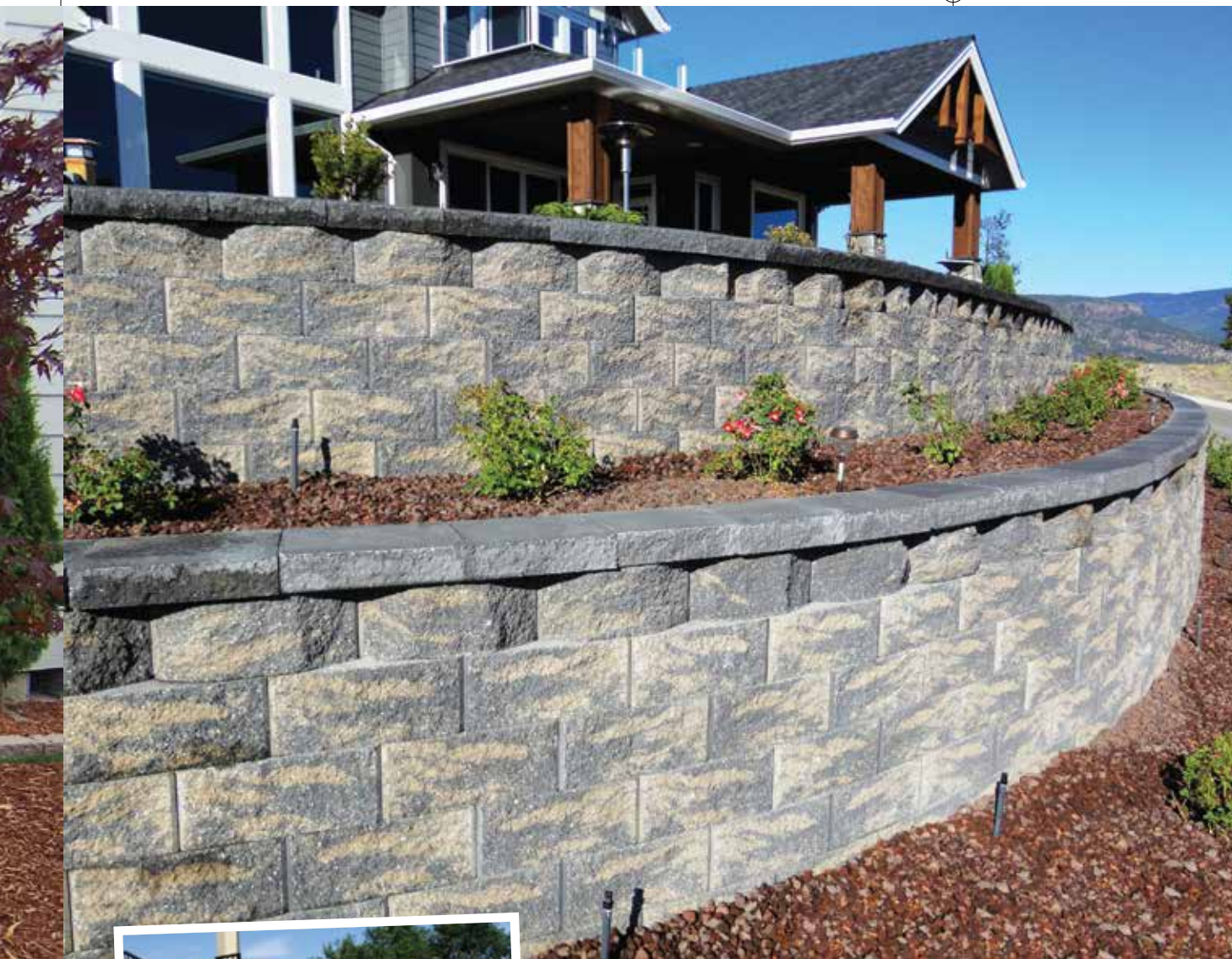

# Geowall™ Pro

## RETAINING WALL

The Geowall™ Pro is the perfect choice for Large Retaining and Terraced wall applications. The Geowall Pro uses a pin system that allows for multiple setback options.

Above, left and below: GeoWall Pro in Tuscany colour.



### COLOURS



Ebony (Special Order)



Tuscany (Special Order)



Roman (Special Order)



Mountain Tan



Grey

NOTE: Printed colours shown in this brochure may vary from actual product colours. We recommend selecting colours from actual product samples. Custom colours are available by special order - please contact your local dealer. Products should be pulled from multiple pallets during installation as colours may vary slightly from pallet to pallet.



# Valley Stone™ Half

## RETAINING WALL

Valley Stone Half has a tapered design to accommodate tight curves and straight walls. With the same features of the regular Valley Stone, Valley Stone Half is lightweight and uses a rear pin and channel connection that makes it easy to install.

Above and right: Valley Stone Half in grey with Ebony colour cap



## COLOURS

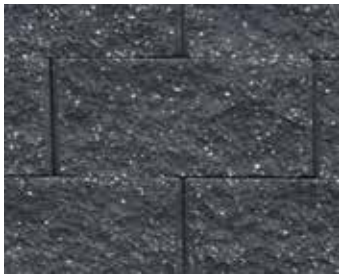

Ebony



Canyon Blend



Roman



Mountain Tan



Grey



# Valley Stone™

RETAINING WALL

Valley Stone™ features a textured, split face appearance with an open core design. Valley Stone is light weight and uses a rear pin and channel connection that make it easy to install. The pin system allows for multiple setback options making Valley Stone the perfect choice for all your retaining wall needs from flower beds to large structural walls.

Left and Above: Valley Stone in Grey colour.

### COLOURS

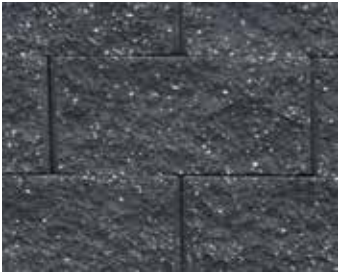

Ebony



Canyon Blend



Roman



Mountain Tan



Grey

NOTE: Printed colours shown in this brochure may vary from actual product colours. We recommend selecting colours from actual product samples. Custom colours are available by special order - please contact your local dealer. Products should be pulled from multiple pallets during installation as colours may vary slightly from pallet to pallet.



## Artisan Slate Premier

### INTERLOCKING PAVING STONES

Artisan Slate Premier is designed to provide a bold paver solution with the highest of flexibility in design patterns. Highlighted by a large 12"x12" paver, each stone features subtle textures that provide the look of real stone combined with the strength and durability of an interlocking paving stone.

Above: Artisan Slate Premier in Torino colour  
Right: Right: Artisan Slate Premier in Positano colour with high gloss sealer

*For Artisan Slate Premier patterns and installation instructions please visit [basalite.ca](http://basalite.ca)*

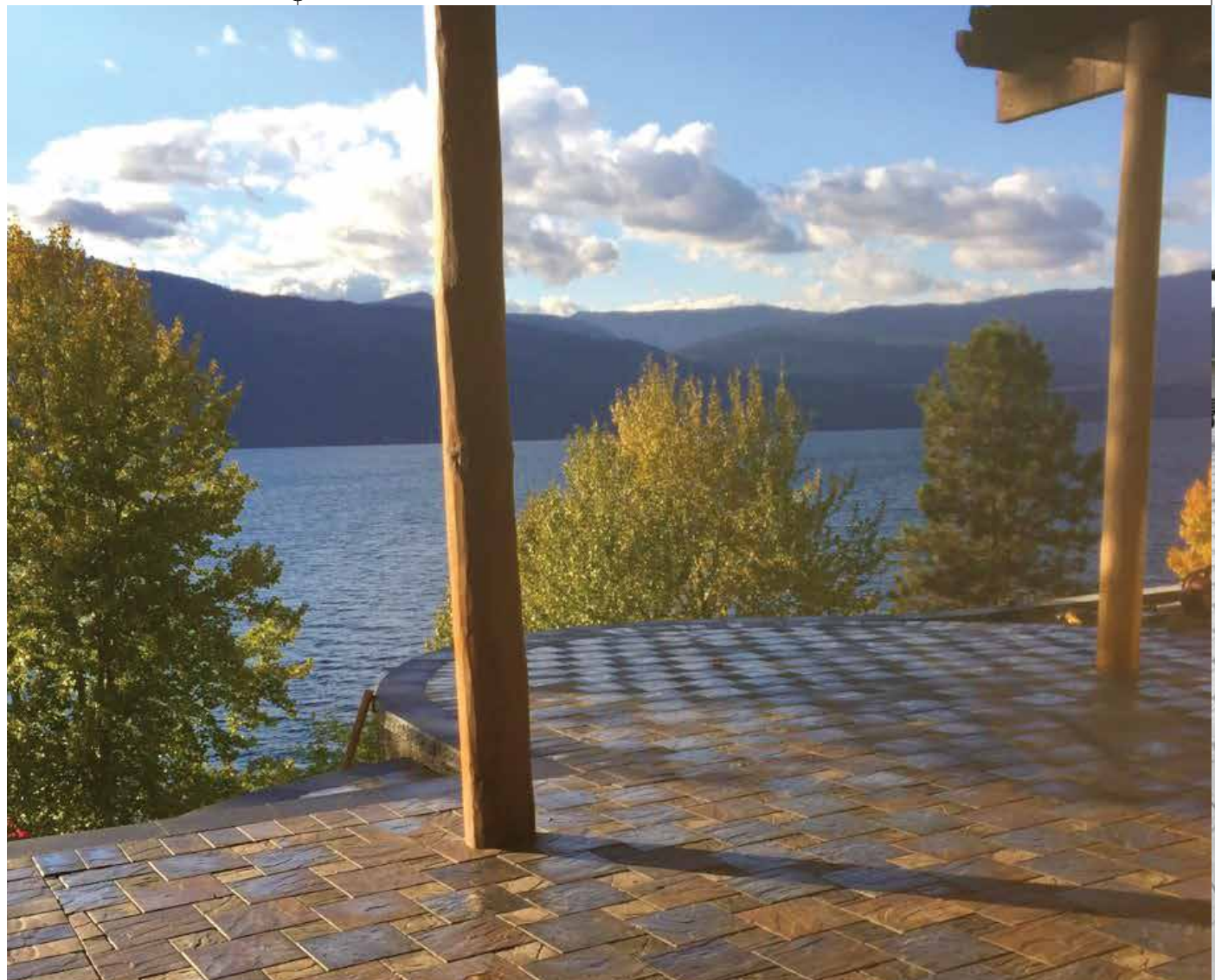

Positano



Torino





# Mission

## INTERLOCKING PAVING STONES

For a more traditional approach to landscape design, try Basalite® Mission Pavers. Even with its simple shape, Mission pavers can be arranged in several appealing patterns, such as Herringbone, Basket Weave, or Running Bond.

Left: Mission Pavers in Natural and Ebony colours.  
 Center: Mission Pavers in Torino colour.  
 Above: Mission Pavers in Natural and Ebony colours.



Natural



Ebony



Torino



Verona

*For Mission patterns and installation instructions please visit [basalite.ca](http://basalite.ca)*

NOTE: Printed colours shown in this brochure may vary from actual product colours. We recommend selecting colours from actual product samples. Custom colours are available by special order - please contact your local dealer. Products should be pulled from multiple pallets during installation as colours may vary slightly from pallet to pallet.

# Curves

Convex or concave curves are easy to construct with Basalite products and will add gentle grace to any project. For walls with several concave curves, use the near vertical setback pin placement option for best results. Place the units to follow the desired curve. If unit to unit geometry creates small "V" shaped voids on the retained soil side, just fill these areas with drainage fill.

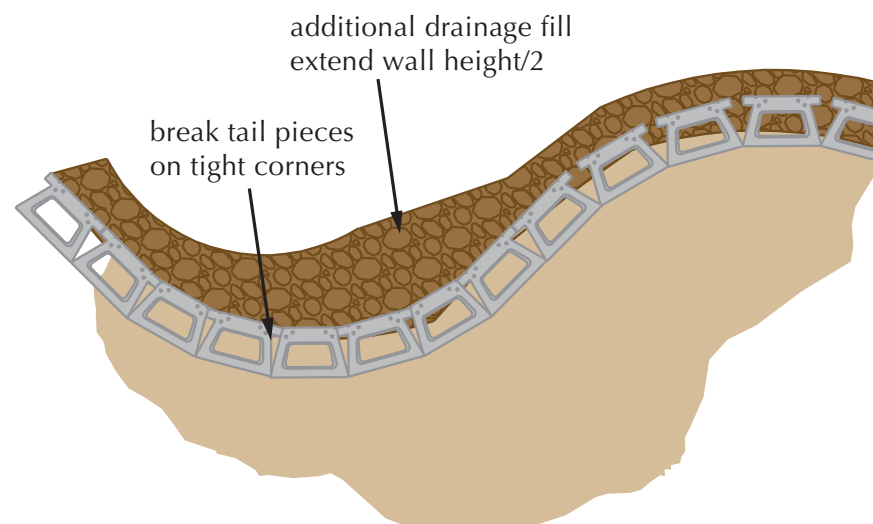
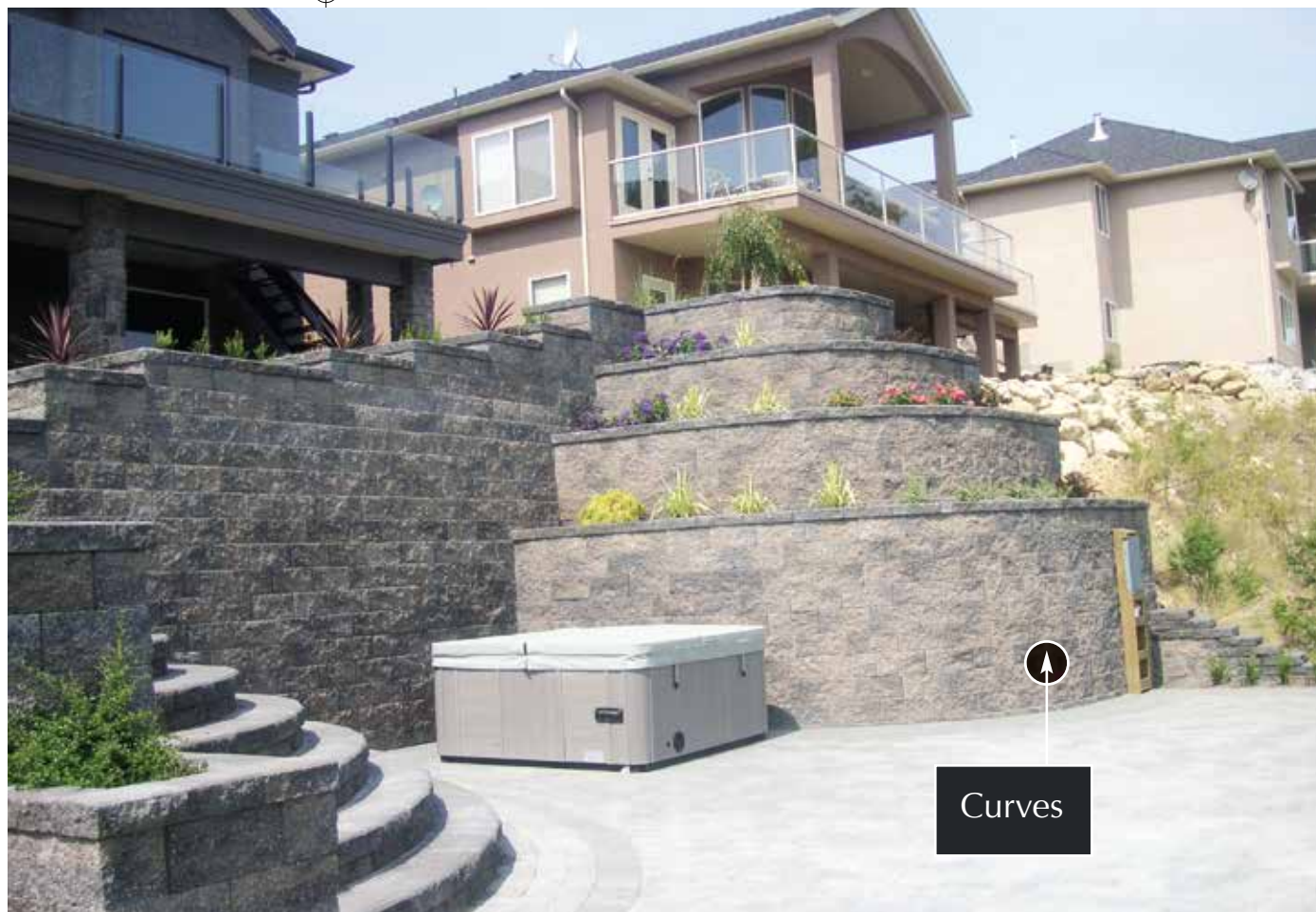

*For walls with several concave curves, use the near vertical setback pin placement option for best results.*

Above: GeoWall Pro in Tuscany colour (Straight and Sculpted face).  
Top right: Valley Stone in Canyon Blend colour.



# Corners

With Basalite, corners are a natural part of your creative design. Nearly all Basalite products are capable of creating a 90° inside or outside corner using a multi-faced unit. For details on how to create 90° corners for your Basalite system, contact your local Basalite distributor.

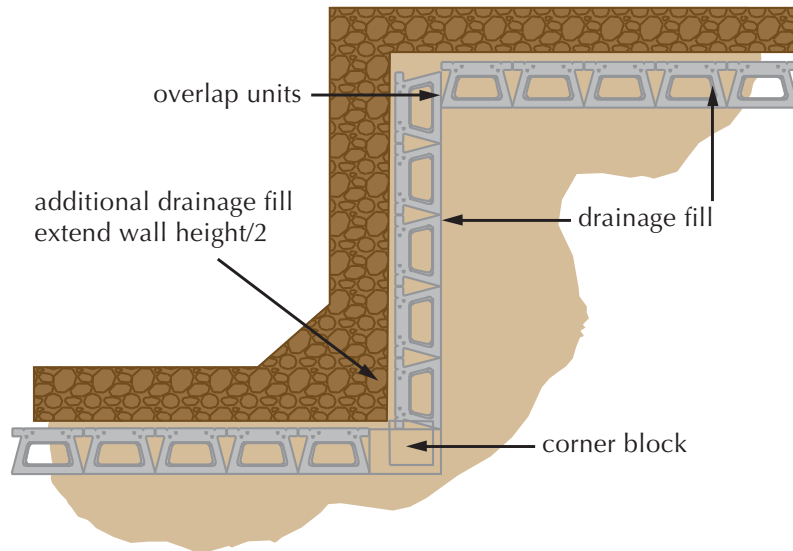

*Nearly all Basalite products are capable of creating a 90° inside or outside corner using a multi-faced unit.*

Top left and above: Valley Stone in Grey colour.

NOTE: Printed colours shown in this brochure may vary from actual product colours. We recommend selecting colours from actual product samples. Custom colours are available by special order - please contact your local dealer. Products should be pulled from multiple pallets during installation as colours may vary slightly from pallet to pallet.

# Stairs

Stairs can be easily designed with graceful curves or right angle corners to compliment your landscape project. Basalite retaining walls deliver several attractive face options for building steps and stairs. Stairs layouts can be customized to suit any application.



*Basalite retaining walls deliver several attractive face options for building steps and stairs.*

Above: Valley Stone in Mountain Tan colour  
Right: Valley Stone in Canyon Blend colour.

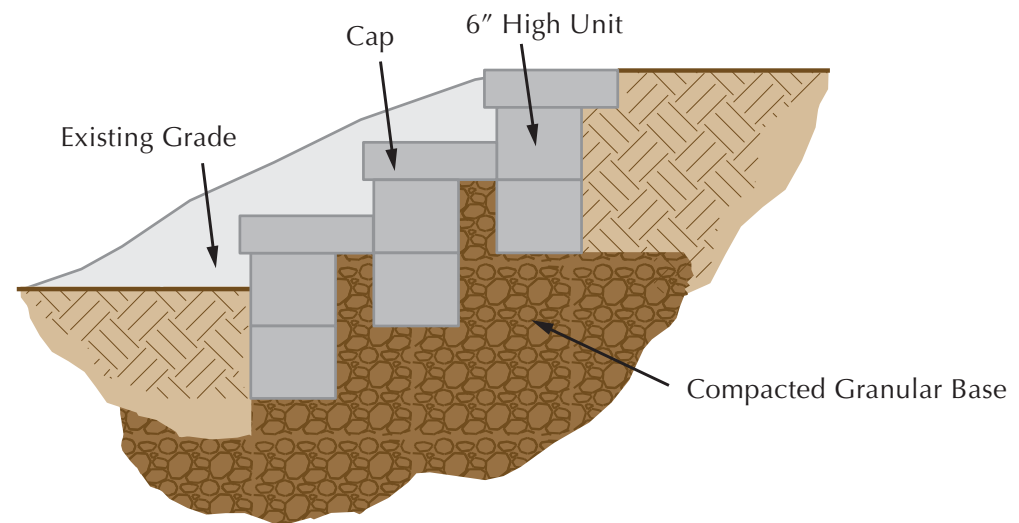
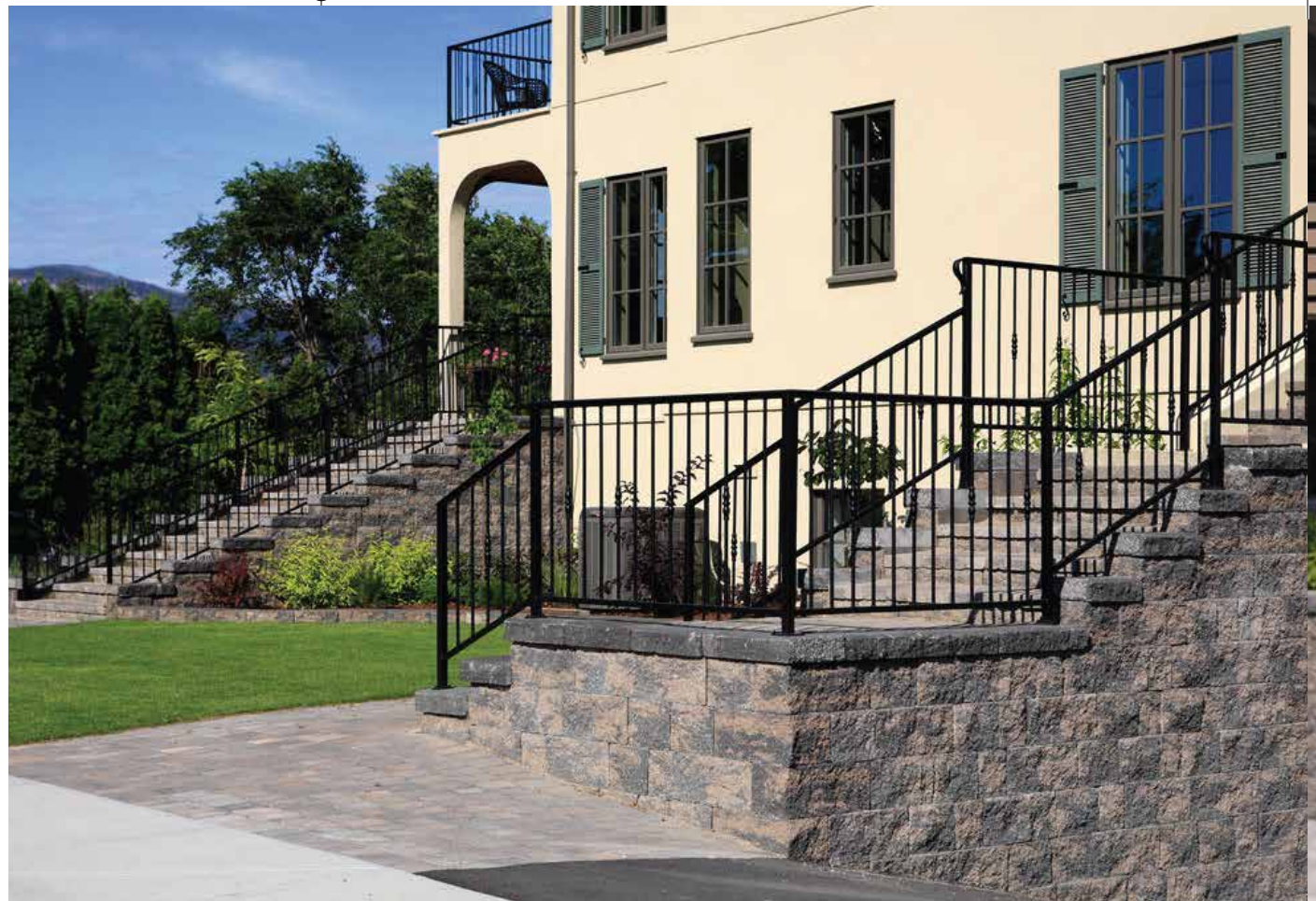

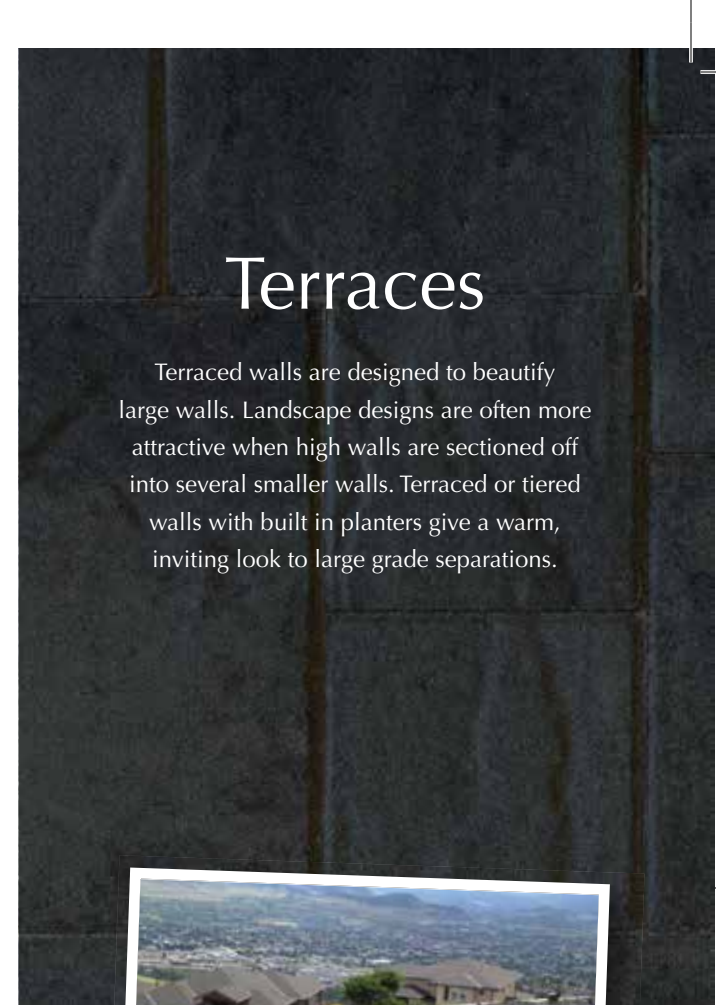

# Terraces

Terraced walls are designed to beautify large walls. Landscape designs are often more attractive when high walls are sectioned off into several smaller walls. Terraced or tiered walls with built in planters give a warm, inviting look to large grade separations.

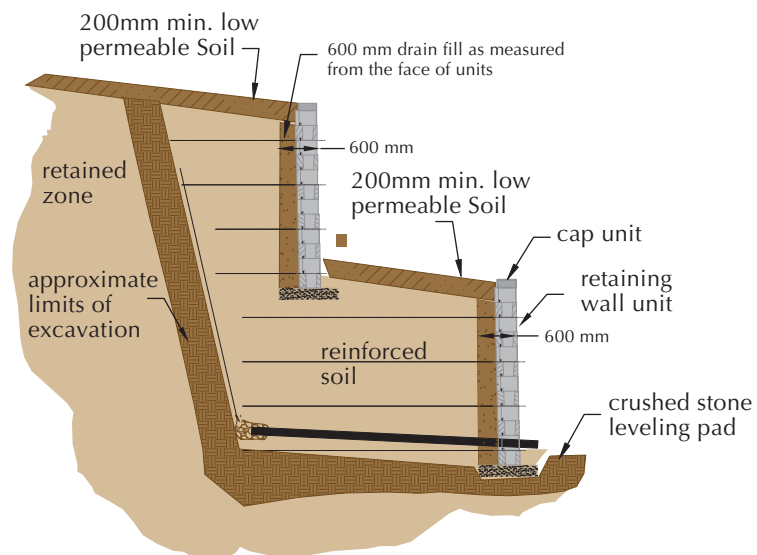

*Terraced or tiered walls with built in planters give a warm, inviting look to large grade separations.*

Top left: Valley Stone in Canyon Blend colour.  
Above: Valley Stone in Mountain Tan colour.

NOTE: Printed colours shown in this brochure may vary from actual product colours. We recommend selecting colours from actual product samples. Custom colours are available by special order - please contact your local dealer. Products should be pulled from multiple pallets during installation as colours may vary slightly from pallet to pallet.



# Necessaries™ Outdoor Living Kits

Necessaries™ Outdoor Living Kits is a collection of ready-to-assemble outdoor fireplaces, waterfalls, bars, tables, fire pits, pillars, seat walls and patio kits. Each kit comes with everything you need to build. See pages 19-16 for additional information.

Top left: Pub Table in Desert colour - Top middle: Grand Waterfall in Desert colour. - Top right: Compact Bar Open Front in Desert colour - Lower left: Compact Bar with Grill Kit in Sante Fe colour. Lower Right: Grand Fire Pit with Grate and Spark Screen in Sante Fe colour.



## COLOURS



Santa Fe



Desert



Bluestone

### Woodgrain Pavers

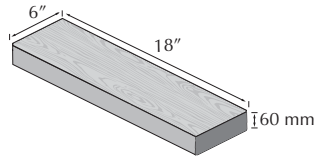

Style: 6"x18"  
Weight: 20 lb  
Units/Pallet: 112  
Sq.Ft./Pallet: 80

### Plank Pavers

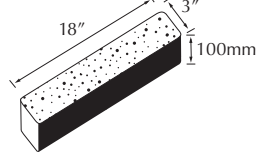

Style: 3"x18"  
Weight: 16 lbs  
Units/Pallet: 140  
Sq.Ft./Pallet: 51

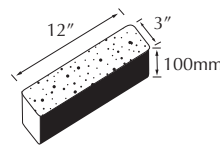

Style: 3"x12"  
Weight: 11 lbs  
Units/Pallet: 280  
Sq.Ft./Pallet: 68

### Artisan Slate Premier

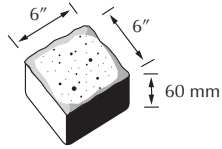

Style: 6"x6"  
Weight: 7 lb  
Units/Pallet: 448  
Sq.Ft./Pallet: 112

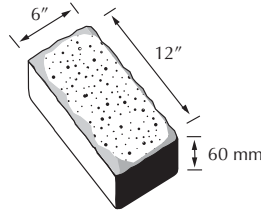

Style: 6"x12"  
Weight: 13.5 lbs  
Units/Pallet: 224  
Sq.Ft./Pallet: 112

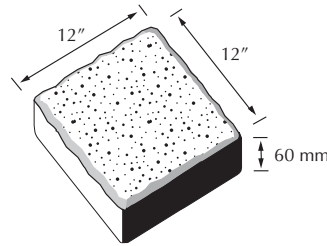

Style: 12"x12"  
Weight: 20 lbs  
Units/Pallet: 112  
Sq.Ft./Pallet: 112

### Mission Pavers

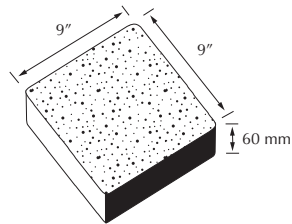

Style: Mission Double  
Weight: 15 lbs  
Units/Pallet: 175  
Sq. Ft./Pallet: 95.4

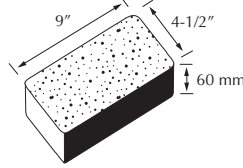

Style: Mission Standard  
Weight: 7.5 lbs  
Units/Pallet: 350  
Sq. Ft./Pallet: 95.4

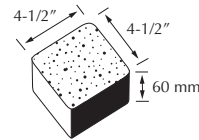

Style: Mission Half  
Weight: 4 lbs  
Units/Pallet: 700  
Sq. Ft./Pallet: 95.4

### Concrete Slabs

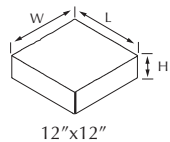

12"x12"

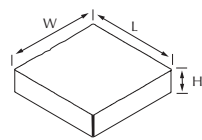

18"x18"

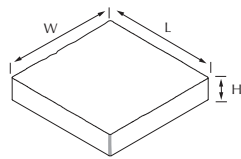

24"x24"

Name	Texture	Metric Dimensions	Imperial Dimensions	Weight
12x12 Natural	Smooth	303mm W x 303mm L x 45mm H	11.93" W x 11.93" L x 1.77" H	10 kg
18x18 Natural	Smooth	455mm W x 455mm L x 45mm H	17.91" W x 17.91" L x 1.77" H	23 kg
18x18 Charcoal	Smooth	455mm W x 455mm L x 45mm H	17.91" W x 17.91" L x 1.77" H	23 kg
24x24 Natural	Smooth, Slate or Washed	608mm W x 608mm L x 50mm H	23.94" W x 23.94" L x 1.97" H	40.5 kg
24x24 Charcoal	Smooth	608mm W x 608mm L x 50mm H	23.94" W x 23.94" L x 1.97" H	40.5 kg

For design consideration add 2mm or .07" to the W and L dimensions to allow for the spacers.

### Garden Stack

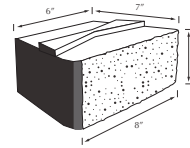

Style: Standard Unit  
Weight: 15 lbs  
Units / Pallet: 180

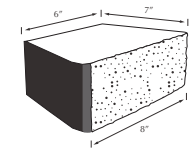

Style: Cap Unit  
Weight: 15 lbs  
Units / Pallet: 180

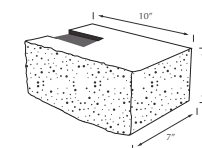

Style: Return Unit  
Weight: 15 lbs  
Units / Pallet: 48

### Valley Stone™ Half

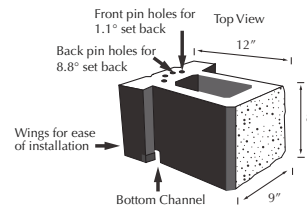

Style: Half Unit  
Weight: 44 lbs  
Units / Pallet: 48

### Valley Stone™

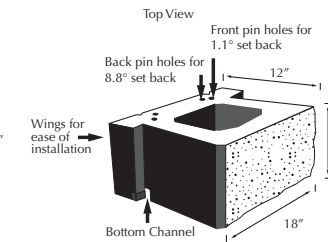

Style: Standard Unit  
Weight: 80 lbs  
Units / Pallet: 40

### Geowall™ Pro

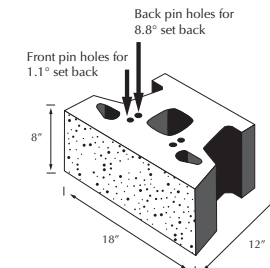

Style: Straight Face  
Weight: 97 lbs  
Units / Pallet: 32

### Caps & Corner Block for Valley Stone™, Valley Stone™ Half & GeoWall Pro

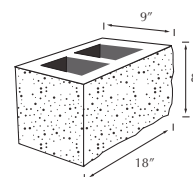

Style: Corner  
Weight: 38kg (83lbs)  
Units/Pallet: 30

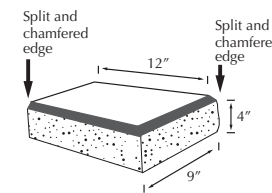

Style: Corner Cap  
Weight: 15kg (33lbs)  
Available in left-hand and right-hand corners.

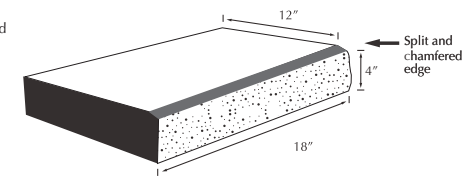

Style: Cap  
Weight: 29.9kg (66lbs)  
Units/Pallet: 48

NOTE: Weights, units/pallet and square feet/pallet are estimated. All measurements are nominal.

### Grand 8' Bar With Grill & Refrigerator Opening

Kit includes: pre-cut block, instructions, Vermont Castings signature series 324 stainless gas grill (built-in), 24" W x 16" H stainless steel door with storage, steel reinforcements and adhesive. Weight: 7331 lbs.

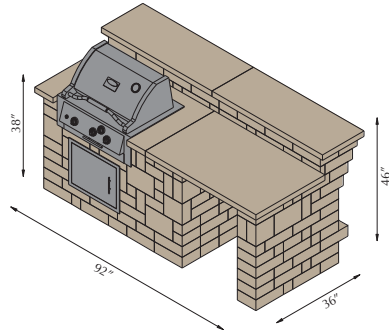

### Grand Corner Return

Kit includes: pre-cut block, instructions, steel reinforcements and adhesive. Weight: 5130 lbs.

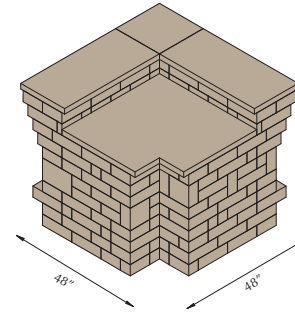

### Grand 4' Bar

Kit includes: pre-cut block, instructions, steel reinforcements and adhesive. Weight: 3770 lbs.

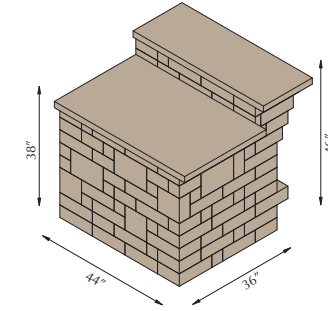

### Grand 8' Bar With Grill & Door

Kit includes: pre-cut block, instructions, Vermont Castings signature series 324 stainless gas grill (built-in), 24" W x 24" H stainless steel door with storage, steel reinforcements and adhesive. Weight: 7331 lbs.

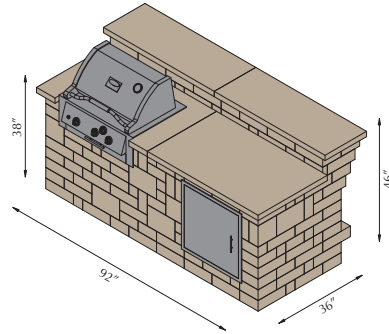

### Grand Grill Surround

Kit includes: pre-cut block, instructions, steel reinforcements and adhesive. Weight: 4905 lbs.

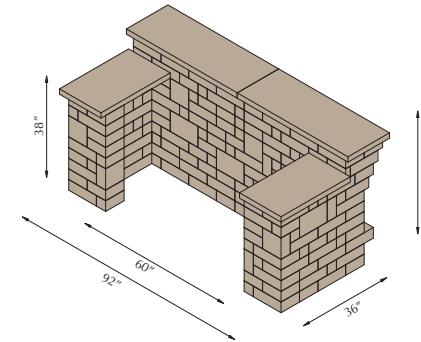

### Grand 8' Island Bar

Kit includes: pre-cut block, instructions, steel reinforcements and adhesive. Weight: 7261 lbs.

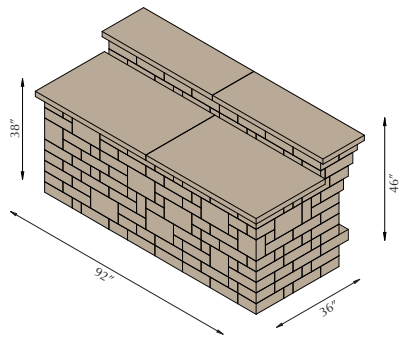

### Compact Bar Front Open

Kit includes: pre-cut block, instructions and adhesive. Weight: 2820 lbs.

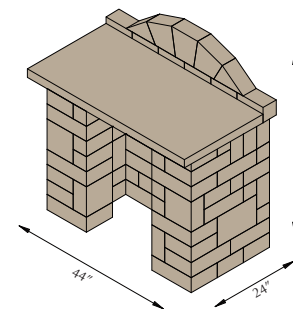

### Compact Bar Front Closed

Kit includes: pre-cut block, instructions and adhesive. Weight: 2820 lbs.

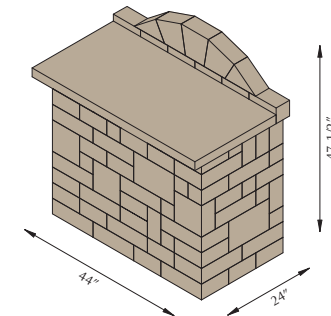



### Dining Table

Kit includes: pre-cut block, instructions, steel reinforcements and adhesive. Weight: 2860 lbs.

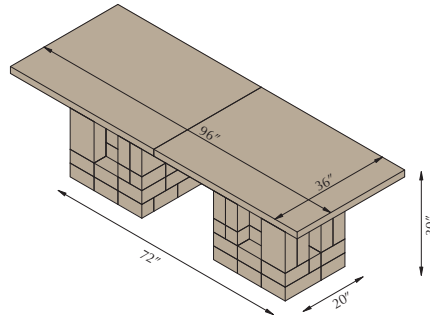

### Grand Waterfall

Kit includes: pre-cut block, instructions, 1350 gph mag drive pump, 48" square basin and all connections, 23" stainless steel spillway, steel reinforcements, adhesive and gloves. Weight: 3465 lbs.

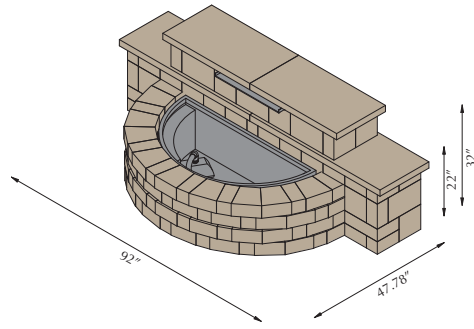

### 20 inch Column

Kit includes: pre-cut block, instructions and adhesive. Weight: 1250 lbs.

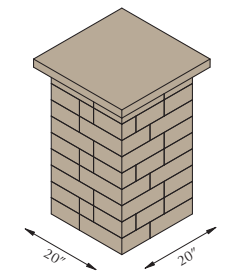

### 24 inch Column

Kit includes: pre-cut block, instructions and adhesive. Weight: 1655 lbs.

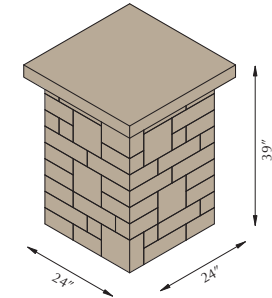

### Pub Table

Kit includes: pre-cut block, 36" octagon limestone table top, instructions and adhesive. Weight: 1505 lbs.

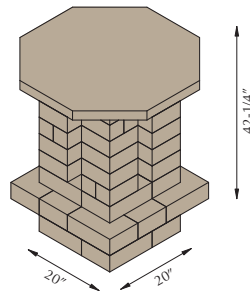

### Compact Waterfall

Kit includes: pre-cut block, instructions, 850 gph mag drive pump, 26" square basin, 11" stainless steel spillway, steel reinforcements, adhesive and gloves. Weight: 1650 lbs.

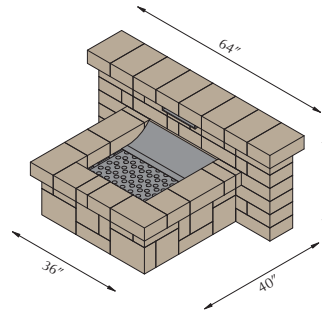

### Lakeland Seatwall

Kit includes: pre-cut block, instructions and adhesive. Weight: 1060 lbs.

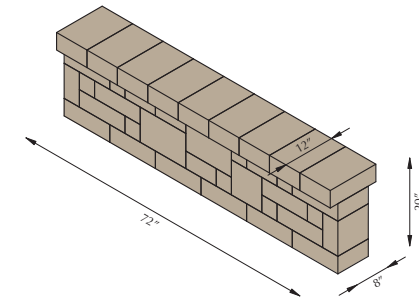

### Bistro Table

Kit includes: pre-cut block, 36" octagon limestone table top, instructions and adhesive. Weight: 1505 lbs.

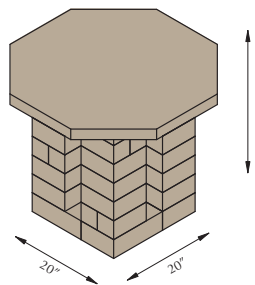

### 20 inch Column with Glass

Kit includes: pre-cut block, instructions, adhesive and Pittsburgh Corning® Premiere glass block. Weight: 1140 lbs.

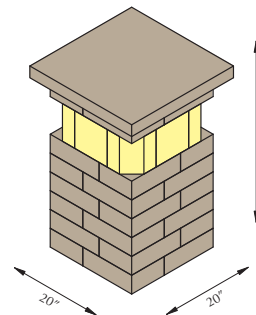

### Riverland Seatwall

Kit includes: pre-cut block, instructions and adhesive. Weight: 1390 lbs.

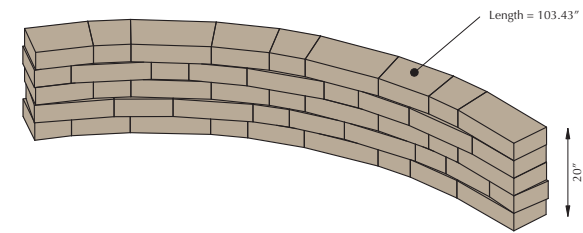

NOTE: Weights and measurements are estimated.

### Grand Fireplace Kit

Kit includes: pre-cut block, instructions, Lennox Hearth Products 36" stainless steel wood-burning insert, 4" stainless steel stovepipe chimney and spark suppressor cap, steel reinforcements and adhesive. Weight: 9667 lbs.

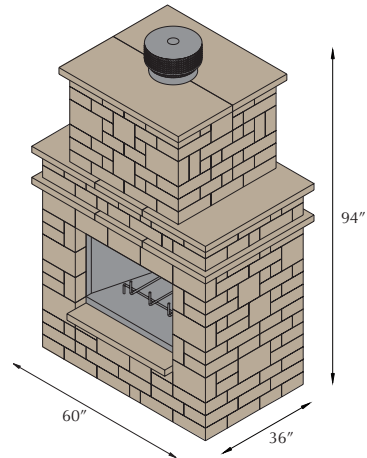

### Grand Wood Box Kit

Kit includes: pre-cut block, instructions, steel reinforcements and adhesive. Available left or right side. Weight: 4051 lbs

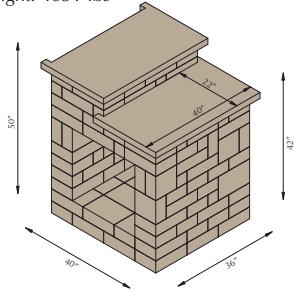

### Grand Hearth Kit

Kit includes: pre-cut block, instructions and adhesive. Weight: 699 lbs

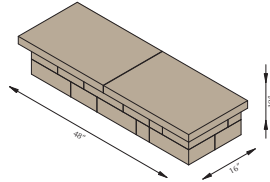

### Colonial Fireplace Kit

Kit includes: pre-cut block, instructions, protective fire brick, steel reinforcements and adhesive. Weight: 3725 lbs.

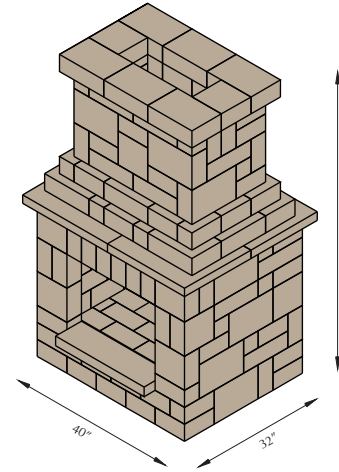

### Colonial Wood Box Kit

Kit includes: pre-cut block, instructions and adhesive. Available left or right side. Weight: 1655 lbs

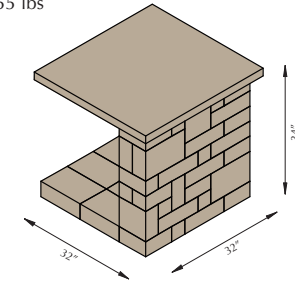

### Colonial Hearth Kit

Kit includes: pre-cut block, instructions and adhesive. Weight: 285 lbs

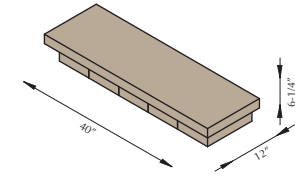

### Contemporary Fireplace Kit

Kit includes: pre-cut block, instructions, Fire Gear, stainless steel gas burning insert, 43,000+ Btu's, 30" natural gas or LP burner, electronic ignition, on/off switch, stainless steel access door and adhesive. Weight: 4690 lbs.

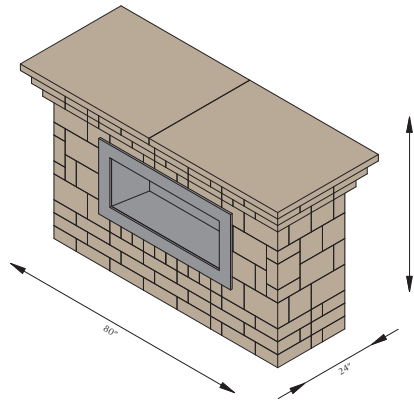

### Contemporary Hearth Kit

Kit includes: pre-cut block, instructions and adhesive. Weight: 699 lbs

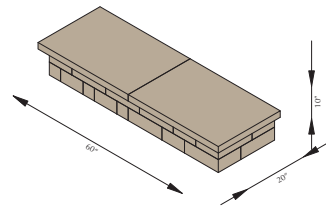

### Victorian Fireplace Kit

Kit includes: pre-cut block, instructions, protective fire brick, steel reinforcements and adhesive. Weight: 4600 lbs.

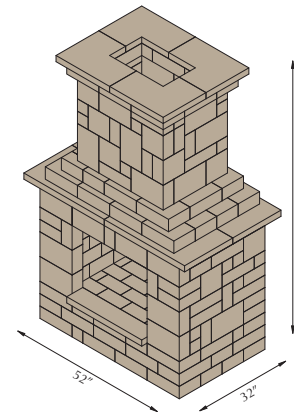

### Victorian Wood Box Kit

Kit includes: pre-cut block, instructions and adhesive. Available left or right side. Weight: 2090 lbs

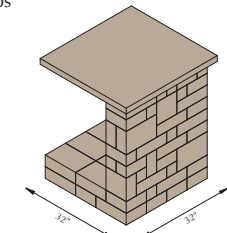

### Victorian Hearth Kit

Kit includes: pre-cut block, instructions and adhesive. Weight: 699 lbs

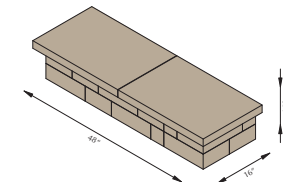

### Compact Fireplace Kit

Kit includes: pre-cut block, instructions, protective fire brick, steel reinforcements and adhesive. Weight: 3725 lbs.

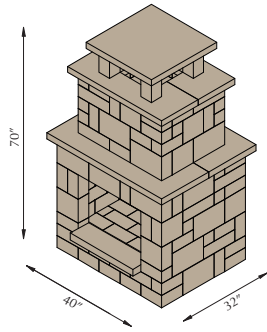

### Compact Wood Box Kit

Kit includes: pre-cut block, instructions and adhesive. Available left or right side. Weight: 1655 lbs

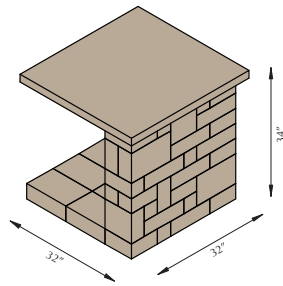

### Compact Hearth Kit

Kit includes: pre-cut block, instructions and adhesive. Weight: 285 lbs

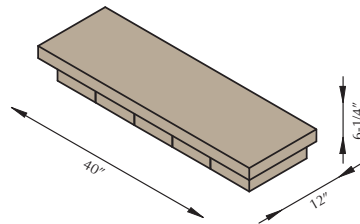

### Grand Fire Pit Kit With Grate

Kit includes: heavy duty, ADA compliant steel grate, heavy gauge, solid steel ring insert, precut block, adhesive, gloves and instructions.

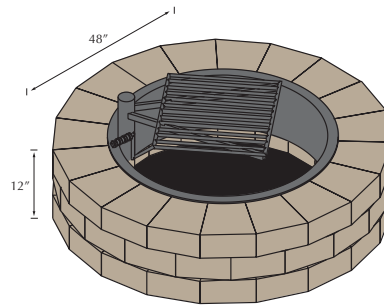

### Grand Fire Pit Kit With Ring

Kit includes: heavy gauge, solid steel ring insert, precut block, adhesive, gloves and instructions.

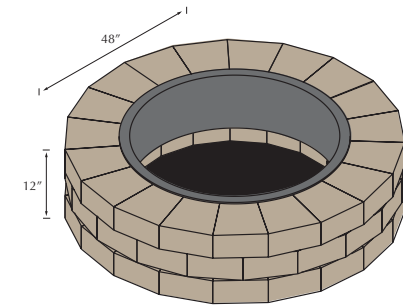

### Victorian Fire Pit Kit With Grate

Kit includes: heavy duty, ADA compliant steel grate, heavy gauge, solid steel insert, precut block, adhesive, gloves and instructions.

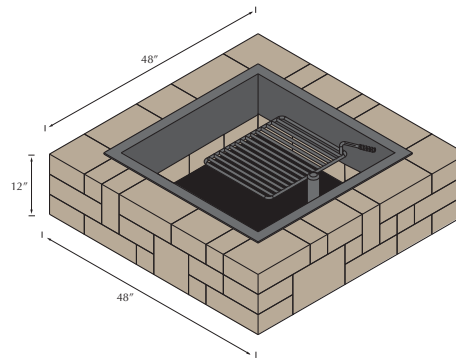

### Victorian Fire Pit Kit With Ring

Kit includes: heavy gauge, solid steel insert, precut block, adhesive, gloves and instructions.

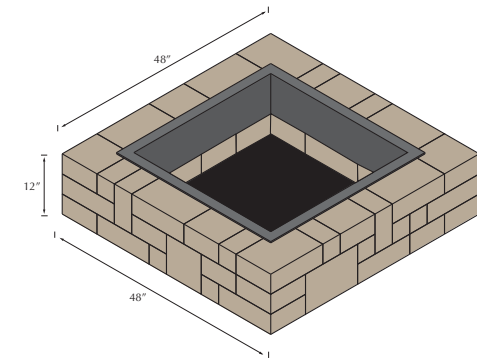

NOTE: Weights and measurements are estimated.

## Typical Retaining Wall Installation\*

Includes Valley Stone, Valley Stone Half and GeoWall Pro.

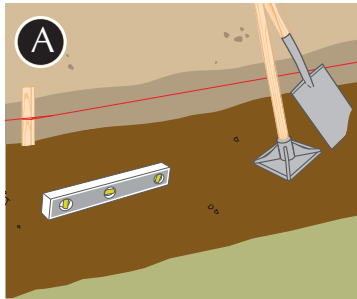

### A. Prepare The Base Leveling Pad

Start by digging a shallow trench 4" deep by 24" wide. Cut through and remove any sod, roots or large rocks. For organic loam soils, dig 4" deeper and add a leveling pad of sand or gravel. Compact and level the soil to receive the first course of block.

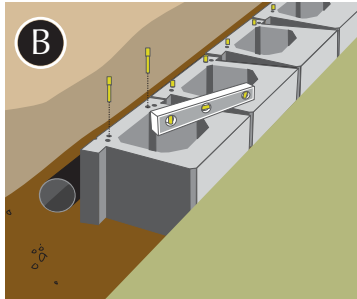

### B. Base Course

Place the first Valley Stone with the channel facing down. Level each unit on the base course as you place it, make sure that the outside edges touch. Place wall pins in the appropriate holes, front pinholes are for vertical positions and back pin holes for setback positions. If your wall contains both straight

and curved areas, start with the straight area and build into the curves. Complete the base course before proceeding to the second course. A drainage pipe should be placed at rear base of first course.

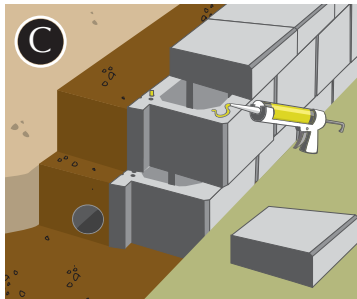

### C. Stacking and Fill

Starting with straight areas first, place the next course of Valley Stone units over the pins. Center each unit on the seams of the course below in a running bond pattern as shown. Now proceed to the next layer backfilling as you go. For drainage behind the wall, use clean gravel or crushed stone. With the top units dry and clean,

stack the caps on top of the final row and use a construction adhesive to secure. Caps will need to be cut for walls that have radiuses.

## Garden Stack Wall Installation\*

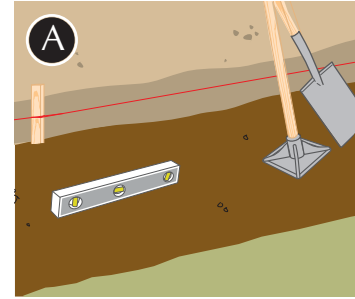

### A. Prepare The Base Leveling Pad

Start by digging a shallow trench 4" deep by 12" wide. Cut through and remove any sod, roots or large rocks. For organic loam soils, dig 4" deeper and add a leveling pad of sand or gravel (Basalite Base Gravel). Compact and level the soil to receive the first course of block.

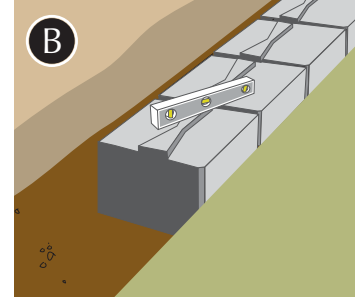

### B. Base Course

Place and level the first Basalite Garden Stack unit. Level each additional unit on the base course as you place it, making sure that the outside edges touch. If your wall contains both straight and curved areas, start with a straight area and build into the curves. Complete the base course before proceeding to the second course.

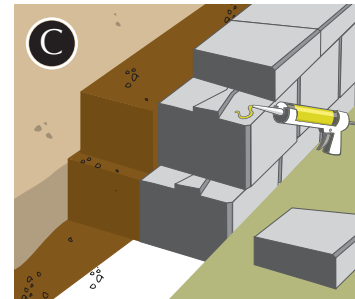

### C. Stacking and Capping

Starting with straight areas first, begin placing the second course. Center each Basalite Garden Stack unit on the seams of the course below in a running bond pattern as shown. Adhere caps into place with a flexible concrete adhesive.

\* Garden Stack maximum height is 18" (46cm)

\*The Valley Stone and Geowall Retaining Wall systems can be used for gravity walls up to 3 feet high, including buried covers, but excluding the cap. Taller walls can be built with the retaining wall system using geosynthetic reinforcement when designed by a qualified engineer. Height assumes level backfill and clean, compacted sand or gravel with no surcharge.

### Garden Stack

For curved or straight retaining walls.

Project Estimating Chart						
Wall Height	Wall Length (Measured at wall face including curves.)					
	4'	8'	12'	16'	20'	24'
4" (1 course)	6	12	18	24	30	36
8" (2 courses)	12	24	36	48	60	72
12" (3 courses)	18	36	54	72	90	108
16" (4 courses)	24	48	72	96	120	144
20" (5 courses)	30	60	90	120	150	180

\*\* Minimum Inside Diameter 36" (20 blocks)

### Valley Stone & Geowall Pro

For curved or straight retaining walls.

Project Estimating Chart						
Wall Height	Wall Length (Measured at wall face including curves.)					
	6'	12'	18'	24'	30'	36'
8" (1 course)	4	8	12	16	20	24
16" (2 courses)	8	16	24	32	40	48
24" (3 courses)	12	24	36	48	60	72
32" (4 courses)	24	32	48	64	80	96
40" (5 courses)	20	40	60	80	100	120

### Valley Stone

For curved retaining walls.

Standard Unit Radius Chart				
Setback	Wall Height			
	1.2 m (4')	1.8m (6')	2.4 m (8')	3 m (10')
1.0	1.44 m (4'10")	1.52 m (5')	1.61 m (5'4")	1.71 m (5'9")
8.8	1.62 m (5'3")	1.72 m (5'6")	1.82 m ( 06')	1.92 m (6'4")

Valley Stone Half Radius Chart				
Setback	Wall Height			
	1.2 m (4')	1.8m (6')	2.4 m (8')	3 m (10')
1.0	1 m (3'3")	1.1 m (3'8")	1.2 m (4')	1.35 m (4'5")
8.8	1.2 m (4')	1.4 m (4'10")	1.6 m ( 5'8")	1.8 m (6'6")

NOTES:  
Recommended approximate radius at base of wall for convex and concave curves. As you go higher in wall height, the radius tightens. Start the radius in the middle of the curve, and work out toward the sides. Use cut pieces at end of curves. These charts are for estimation only.

## PAVER PATTERNS

Running Bond

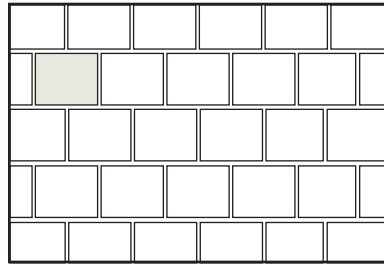

Pinwheel

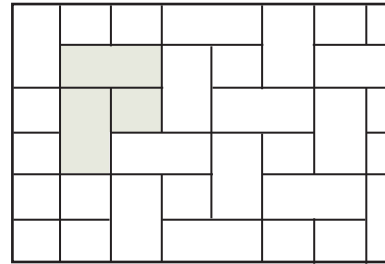

Herringbone Blend

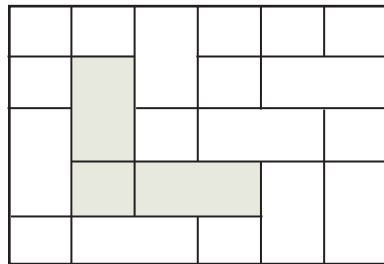

Double Basket Weave

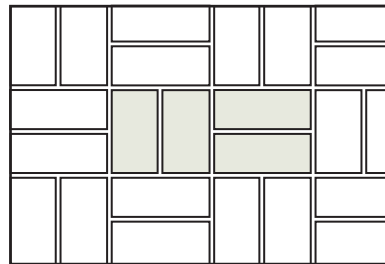

Blend

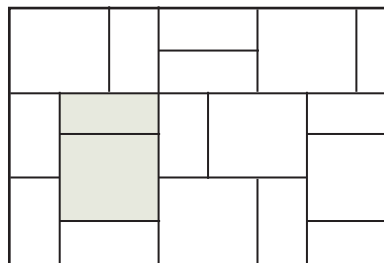

Plaid

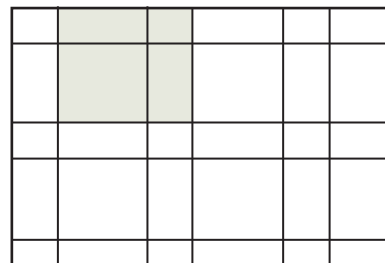

Interlace

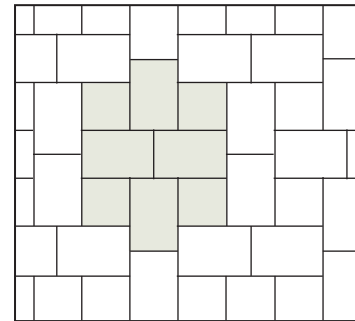

Random Cobble

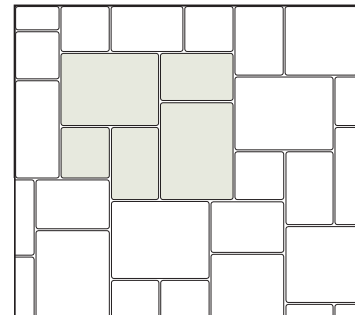

Random 1

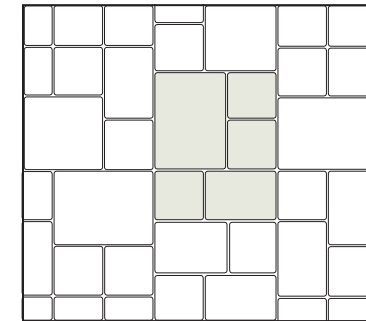

Mega Pattern Two

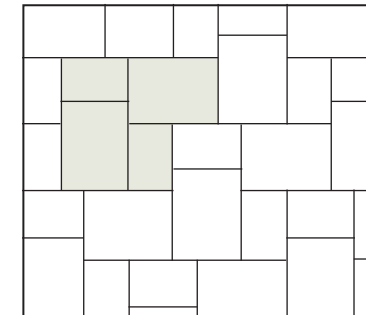

Note: All measurements are nominal and quantities are estimated.



## HARDSCAPES

Basalite Hardscape products are built for maximum design versatility and outstanding durability, so you can have peace of mind every time you step outside. All of our products are manufactured to meet or exceed industry standards, meaning a much more durable outdoor living space that can withstand not only the test of time, but all of the wear and tear life can possibly throw at it.

Above left: GeoWall Pro in Grey colour.  
 Above center: Woodgrain Paver in Driftwood colour.  
 Above right: Plank Pavers in Grey, Charcoal & Ebony colours.  
 Below left: Valley Stone Half in Ebony colour.  
 Below center: 12"x 12"x 45mm Slabs in Natural colour.  
 Below right: Artisan Slate Premier in Positano colour.



Garden Walls

Concrete Slabs

Pavers





## CIVIL SITE SOLUTIONS

At Basalite, you get more than just great products, you get a dedicated team of knowledgeable experts to assist you through every stage of your project.

Top left: Valley Stone in Grey  
Top right: Valley Stone in Mountain Tan with Ebony  
Bottom left: Valley Stone in Canyon Blend  
Bottom center: Geogrid  
Bottom right: Valley Stone in Grey



Retaining & Fence Walls  
Valley Stone Series • Geowall Series



Geogrid



Large Retaining Wall Projects



NOTE: Printed colours shown in this brochure may vary from actual product colours. We recommend selecting colours from actual product samples. Custom colours are available by special order - please contact your local dealer. Products should be pulled from multiple pallets during installation as colours may vary slightly from pallet to pallet.





Front cover: Artisan Slate Premier in Positano colour with sealer.  
Back cover: Artisan Slate Premier in Positano colour.

 **BASALITE**<sup>®</sup>  
Concrete Products  
a division of Pacific Coast Building Products

PAVERS | WALLS | OUTDOOR LIVING KITS

8650 130th Street  
Surrey, BC V3W 1G1  
1-800-596-3844

233183 Range Rd 283  
Rocky View, AB T1X 0J9  
1-800-596-3844

©01/2019 Basalite<sup>®</sup> Concrete Products, LLC.  
All trademarks <sup>®</sup> are registered trademarks.

ALBERTA • BRITISH COLUMBIA • CALIFORNIA  
COLORADO • IDAHO • NEVADA • OREGON  
WASHINGTON • WYOMING

Visit [basalite.ca](http://basalite.ca), find or follow us on

